



Achieving Irrigation 2.0 and 3.0 Efficiencies

December 9, 2015



Speakers

Gabriele Ludwig, Almond Board (Moderator)

Terry Prichard, UCCE Irrigation and Water
Management Specialist Emeritus

Allan Fulton, UCCE – Tehama County





Water Management and Efficiency

Gabriele Ludwig, Almond Board

Almond Irrigation Improvement Continuum



Water Management and Efficiency

Almond Irrigation Improvement Continuum

- Water Management and Efficiency
 - One of four key components of the Accelerated Innovation Management (AIM) program adopted by Almond Board of California's (ABC) Board of Directors.
 - California experts have noted there are a range of tools growers could be implementing without wholly new technologies.
 - Focuses on accelerating almond grower transition and adoption of research based, commercially available, and increasingly water efficient irrigation management and scheduling tools.
 - An Almond Irrigation Improvement Continuum has been developed to describe the steps of this transition.



Almond Irrigation Improvement Continuum

- Three proficiency levels
 - **Level 1.0** (minimum) outlines research-based irrigation management practices that are within reach for all California Almond growers. (Room 310 – 311)
 - **Level 2.0** (intermediate) and **level 3.0** (advanced) advance practices to more sophisticated levels that attain even more “crop per drop.” (Room 307)
- Comprehensive program of irrigation management and scheduling practices in five key areas
 - Assessing irrigation system performance and efficiency regularly
 - Estimating orchard water requirements based on evapotranspiration
 - Determining the water applied
 - Evaluating soil moisture
 - Evaluating plant water status
- Guidance on how to effectively integrate the practices at each level

Almond Irrigation Improvement Continuum

Measurement	1.0 Minimum	2.0 Intermediate	3.0 Advanced
Irrigation System Performance	Evaluate irrigation system for pressure variation and average application rate at least once every 3 years. Correct any diagnosed system performance problems.	Assess distribution uniformity and average application rate by measuring water volume at least every 3 years. Correct any diagnosed system performance problems.	Assess distribution uniformity and average application rate by measuring water volume at least every 2 years. Correct any diagnosed system performance problems.
Applied water	Use application rate and duration of irrigation to determine water applied.	Use water meters to determine flow rate and water applied.	Use water meters to determine applied water and compare to crop water use (ETc, evapotranspiration) to determine irrigation efficiency.
Orchard Water Requirements	Estimate orchard water requirements using “normal year” regional ETc to estimate irrigation demand on a monthly time step.	Estimate orchard water requirements using “normal year” regional ETc – adjusting for current weather and cover crop use on a bi-weekly time step.	Estimate orchard water requirements using “normal year” regional ETc to plan irrigations then use real time ETc data to correct the schedule on a weekly time step.
Soil Moisture	Evaluate soil moisture based upon feel and appearance by augering to at least 3-5 feet. Monitor on a monthly time step.	Use manually operated soil moisture sensors to at least 3-5 feet and monitor on a bi-weekly time step. Use information to ensure calculated water is not over/under irrigating trees.	Use automated moisture sensors that store data over time. Review weekly to ensure calculated water is not over/under irrigating trees.
Plant Water Status	Evaluate orchard water status using visual plant cues just prior to irrigation or on a bi-weekly time step.	Use pressure chamber to measure midday stem water potential just prior to irrigation on a monthly time step. Ensure calculated water applications are not over/under irrigating trees.	Use pressure chamber to measure midday stem water potential prior to irrigation on a weekly time step. Ensure calculated water applications are not over/under irrigating trees. Use it to assess when to start irrigating.
Management			
Integrating Approaches	Combine irrigation system performance data with “normal year” regional ETc estimates to schedule irrigations. Check soil moisture status with auger occasionally.	Use irrigation system performance data with regional estimates of “normal year” ETc to schedule irrigations and adjust based on feedback from monitoring soil moisture or crop water status.	Develop an irrigation schedule based on predicted “normal year” demand, monitor status using soil and plant based methods. Adjust irrigation schedule with real-time ETc as the season progresses.

Almond Irrigation Improvement Continuum Outreach

- The Almond Board's objective is to assist all almond growers in meeting level 1.0 proficiency
- Beyond this, to work with growers to progress along the continuum to levels 2.0 and 3.0 proficiency
- This will be done in partnership with the many trusted and respected technical experts and resources available to California Almonds
 - University of California Cooperative Extension
 - USDA NRCS
 - CSU Fresno, Cal Poly SLO
 - CDFA SWEEP Program
 - Private companies and services, irrigation districts, and others
- Adoption will be assessed via the Almond Sustainability Program
- Web version of Continuum will be available on Almonds.com/Growers after March 1, 2016 and will feature a “More information and Guidance” link in each square explaining how that step can be achieved, answering:
 - What do I need to know?
 - What are the key resources I need?
 - How do I execute?



**Terry Prichard,
UCCE Irrigation and Water Management Specialist Emeritus**

Achieving Irrigation Proficiency levels 2.0 & 3.0

(Moving forward on ABC's Irrigation Improvement Continuum)

Terry Prichard
UCCE Water Management Specialist Emeritus

Allan Fulton
Irrigation and Water Resources Farm Advisor
Tehama, Glenn, Colusa, and Shasta Counties



Big Picture: Good Irrigation Water Management

1. Estimate how much water needs to be applied
 - Tree water use plus some for irrigation inefficiency
2. Know your irrigation system
 - Application rate – in/hr, “how long to apply an inch of water”, gph/tree
3. Check if you are on target
 - Soil moisture monitoring
 - Plant water status
4. Correct irrigations as needed
5. Repeat through the irrigation season

How to do this will be on the ABC web site

Effective Water Management Should:

- Support high yield potential
- Favor desirable nut quality
- Extend orchard life
- Assist pest management
- Use water and energy efficiently
- Contribute to efficient N management
- Include salinity management



Almond Irrigation Improvement Continuum

Measurement	1.0 Minimum	2.0 Intermediate	3.0 Advanced
Irrigation System Performance	Evaluate irrigation system for pressure variation and average application rate at least once every 3 years. Correct any diagnosed system performance problems.	Assess distribution uniformity and average application rate by measuring water volume at least every 3 years. Correct any diagnosed system performance problems.	Assess distribution uniformity and average application rate by measuring water volume at least every 2 years. Correct any diagnosed system performance problems.
Applied water	Use application rate and duration of irrigation to determine water applied.	Use water meters to determine flow rate and water applied.	Use water meters to determine applied water and compare to crop water use (ETc, evapotranspiration) to determine irrigation efficiency.
Orchard Water Requirements	Estimate orchard water requirements using “normal year” regional ETc to estimate irrigation demand on a monthly time step.	Estimate orchard water requirements using “normal year” regional ETc – adjusting for current weather and cover crop use on a bi-weekly time step.	Estimate orchard water requirements using “normal year” regional ETc to plan irrigations then use real time ETc data to correct the schedule on a weekly time step.
Soil Moisture	Evaluate soil moisture based upon feel and appearance by augering to at least 3-5 feet. Monitor on a monthly time step.	Use manually operated soil moisture sensors to at least 3-5 feet and monitor on a bi-weekly time step. Use information to ensure calculated water is not over/under irrigating trees.	Use automated moisture sensors that store data over time. Review weekly to ensure calculated water is not over/under irrigating trees.
Plant Water Status	Evaluate orchard water status using visual plant cues just prior to irrigation or on a bi-weekly time step.	Use pressure chamber to measure midday stem water potential just prior to irrigation on a monthly time step. Ensure calculated water applications are not over/under irrigating trees.	Use pressure chamber to measure midday stem water potential prior to irrigation on a weekly time step. Ensure calculated water applications are not over/under irrigating trees. Use it to assess when to start irrigating.
Management			
Integrating Approaches	Combine irrigation system performance data with “normal year” regional ETc estimates to schedule irrigations. Check soil moisture status with auger occasionally.	Use irrigation system performance data with regional estimates of “normal year” ETc to schedule irrigations and adjust based on feedback from monitoring soil moisture or crop water status.	Develop an irrigation schedule based on predicted “normal year” demand, monitor status using soil and plant based methods. Adjust irrigation schedule with real-time ETc as the season progresses.

Almond Irrigation Improvement Continuum

Measurement	2.0 Intermediate	3.0 Advanced
Irrigation System Performance	Assess distribution uniformity and average application rate by measuring water volume at least every 3 years. Correct any diagnosed system performance problems.	Assess distribution uniformity and average application rate by measuring water volume at least every 2 years. Correct any diagnosed system performance problems.
Applied water	Use water meters to determine flow rate and water applied.	Use water meters to determine applied water and compare to crop water use (ETc, evapotranspiration) to determine irrigation efficiency.
Orchard Water Requirements	Estimate orchard water requirements using “normal year” regional ETc – adjusting for current weather and cover crop use on a bi-weekly time step.	Estimate orchard water requirements using “normal year” regional ETc to plan irrigations then use real time ETc data to correct the schedule on a weekly time step.

Orchard Water Requirements

- A good way to estimate the orchard water use is to estimate the Evapotranspiration (ET).

The sum of evaporation and plant transpiration

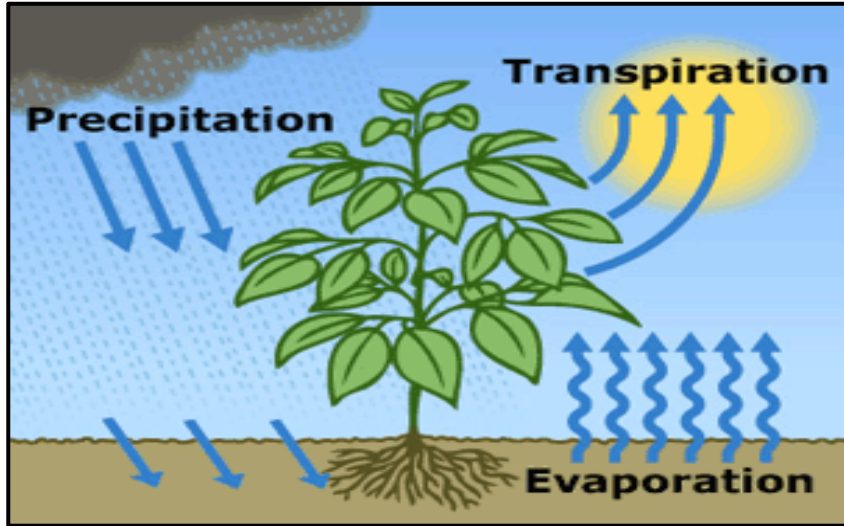

Measuring the weather and then estimating the Evapotranspiration



Estimating Orchard Water Requirements

Two types of ET information are available:

- “Normal Year”, Historic ET_{almond} – Information will be on the web site
 - Uses ET averages over past years – e.g. last 30 years.
 - Good place to start with ET scheduling
 - Very good for planning ahead for irrigations

- “Real-time” or ET Current year -- Currently available from CIMIS – soon on web site
 - More advanced ET scheduling
 - Accounts for “this year” weather which may be different from long-term average
 - Often used by planning irrigations using “normal year” ET, then check with “real-time” ET to correct if needed.

ET Information

- How do you use it?
 - Estimate how much ET (water use) :
 - For the upcoming season
 - For next irrigation cycle
 - For the time since the last irrigation.
 - That amount (plus a little extra for irrigation inefficiency) is the amount of irrigation water you need to apply.



ET Information

Almond Historical ET (inches per month) No cover in orchard middles

Month	K _c	Chico, Fresno, Madera, Modesto, Visalia	Red Bluff, Woodland	Bakersfield, Los Banos	Coalinga Hanford
Jan	0.40	0.5	0.62	0.50	0.62
Feb	0.41	0.81	0.92	0.92	1.04
Mar	0.62	2.11	2.30	2.30	2.49
Apr	0.80	4.09	4.09	4.57	4.57
May	0.94	6.44	6.44	7.02	7.31
June	1.05	8.2	8.20	8.51	9.14
July	1.11	8.93	9.61	9.61	10.30
Aug	1.11	7.90	8.59	8.59	9.28
Sept	1.06	5.73	6.05	6.50	6.68
Oct	0.92	3.41	3.69	3.69	3.97
Nov	0.69	1.23	1.44	1.44	1.64
Dec	0.43	0.40	0.66	0.53	0.66
Total		49.73	52.61	53.73	57.72

From:
"Drought Management for CA
Almonds" by Doll & Shackel
UC ANR Pub. 8515

Will be on ABC web site

ET Information

Historical ET (in/day during period) No cover in orchard middles

Month	Chico, Fresno, Madera, Modesto, Visalia	Red Bluff, Woodland	Bakersfield, Los Banos	Coalinga Hanford
Mar 16-31	0.09	0.07	0.09	0.10
Apr 1-15	0.12	0.09	0.13	0.14
Apr 16-30	0.15	0.12	0.17	0.17
May 1-15	0.20	0.15	0.21	0.22
May 16-31	0.23	0.20	0.25	0.26
June 1-15	0.26	0.23	0.27	0.29
June 16-30	0.28	0.26	0.29	0.31
July 1-15	0.29	0.28	0.31	0.33
July 16-31	0.29	0.31	0.31	0.34
Aug 1-15	0.27	0.31	0.29	0.32
Aug 16-31	0.25	0.29	0.27	0.29
Sept 1-15	0.21	0.27	0.22	0.24
Sept 16-30	0.17	0.22	0.18	0.20
Oct 1-15	0.13	0.18	0.14	0.15
Oct 16-31	0.10	0.14	0.11	0.11
Seasonal Total	49.73	52.61	53.73	57.72

Based on:
"Drought Management for CA
Almonds" by Doll & Shackel
UC ANR Pub. 8515

Will be on ABC web site

Cover Crop Can Use Up to 30% More Water than Clean Middles

- Cover surface coverage
- If cover has access to water



Estimate Orchard Water Requirements Using:

1. “normal year” regional ETc to plan irrigations
2. then use real time ETc data for that period to correct the schedule on the up coming period

ET almond, inches			
	Historical	Real Time	
Modesto	Normal year		
June 1-15	4.1	3.8	Difference 0.3

2015 "Real Time" ET Data

Date	Station	Location	Inches		
			Eto	Kc	ET _{almond}
6/1/2015	71	Modesto	0.23	1.03	0.25
6/2/2015	71	Modesto	0.24	1.03	0.27
6/3/2015	71	Modesto	0.26	1.03	0.26
6/4/2015	71	Modesto	0.25	1.03	0.25
6/5/2015	71	Modesto	0.24	1.03	0.25
6/6/2015	71	Modesto	0.24	1.03	0.27
6/7/2015	71	Modesto	0.26	1.03	0.26
6/8/2015	71	Modesto	0.25	1.03	0.28
6/9/2015	71	Modesto	0.27	1.03	0.22
6/10/2015	71	Modesto	0.21	1.03	0.09
6/11/2015	71	Modesto	0.09	1.03	0.27
6/12/2015	71	Modesto	0.26	1.03	0.29
6/13/2015	71	Modesto	0.28	1.03	0.29
6/14/2015	71	Modesto	0.28	1.03	0.29
6/15/2015	71	Modesto	0.28	1.03	0.30
Sum					3.81

Plan:

June 16-30 Irrigation

$$4.1 - 0.3 = 3.8 \text{ inches}$$

Almond Irrigation Improvement Continuum

Measurement	2.0 Intermediate	3.0 Advanced
Irrigation System Performance	Assess distribution uniformity and average application rate by measuring water volume at least every 3 years. Correct any diagnosed system performance problems.	Assess distribution uniformity and average application rate by measuring water volume at least every 2 years. Correct any diagnosed system performance problems.
Applied water	Use water meters to determine flow rate and water applied.	Use water meters to determine applied water and compare to crop water use (ET _c , evapotranspiration) to determine irrigation efficiency.

Monitor Irrigation System Performance

In field evaluation

- Why is this important?
 - Determine Average Application **Rate** and how evenly (**Uniformity**) water is applied across the orchard.
 - If you know how much you want to apply, you need to know the application rate in order to apply the correct amount of water.

Application Rate – Impact Sprinklers



- First step can be to measure the pressure
 - Measure the pressure and use the chart to get the sprinkler discharge
- Measure volume directly (gal/ min)
- Sprinklers: application rate is measured in in/hr

$$\text{Sprinkler Application Rate (in/hr)} = \frac{96.3 \times (\text{Sprinkler discharge-gpm})}{\text{Sprinkler spacing In tree row (ft)} \times \text{Sprinkler spacing across tree row (ft)}}$$



Table 2. Sprinkler discharge rates (gpm) for various nozzle sizes (in) and pressures (psi)

Pressure (psi)	Nozzle size (in)										
	3/32	7/64	1/8	9/64	5/32	11/64	3/16	13/64	7/32	15/64	1/4
20	1.17	1.60	2.09	2.65	3.26	3.92	4.69	5.51	6.37	7.32	8.34
25	1.31	1.78	2.34	2.96	3.64	4.38	5.25	6.16	7.13	8.19	9.32
30	1.44	1.95	2.56	3.26	4.01	4.83	5.75	6.80	7.86	8.97	10.21
35	1.55	2.11	2.77	3.50	4.31	5.18	6.21	7.30	8.43	9.69	11.03
40	1.66	2.26	2.96	3.74	4.61	5.54	6.64	7.80	9.02	10.35	11.79
45	1.76	2.39	3.13	3.99	4.91	5.91	7.03	8.30	9.60	10.99	12.50
50	1.85	2.52	3.30	4.18	5.15	6.19	7.41	8.71	10.10	11.58	13.18
55	1.94	2.64	3.46	4.37	5.39	6.48	7.77	9.12	10.50	12.15	13.82
60	2.03	2.76	3.62	4.50	5.65	6.80	8.12	9.56	11.05	12.68	14.44
65	2.11	2.88	3.77	4.76	5.87	7.06	8.45	9.92	11.45	13.21	15.03
70	2.19	2.99	3.91	4.96	6.10	7.34	8.78	10.32	11.95	13.70	15.59
75	2.27	3.09	4.05	5.12	6.30	7.58	9.08	10.66	12.32	14.19	16.14

Note: Metric conversions: 1 gal = 3.785 l; 1 in = 2.54 cm; 1 psi = 6.89 kPa

Application Rate – Nelson Rotator Sprinklers

- First step can be to measure the pressure -- use chart
- Sprinklers: application rate is measured in in/hr



$$\text{Sprinkler Application Rate (in/hr)} = \frac{96.3 \times (\text{Sprinkler discharge-gpm})}{\text{Sprinkler spacing In tree row (ft)} \times \text{Sprinkler spacing across tree row (ft)}}$$

- To measure pressure:
Remove the head and replace with pressure gauge

R10 Plate/Nozzle Options and Flow Performance in GPM and LPH

Plate Series	Plate Options	Recommended Nozzles	PSI					BAR							
			25	30	35	40	45	50	1.75	2	2.25	2.5	2.75	3	3.25
P2	P2 9" Red Radius 18-20' (5.5-6.1 m) Stream Ht. 14-23" (36-58 cm)	Lt. Blue #40	—	—	.28	.30	.32	.34	—	—	61.4	64.7	68.0	71.3	74.6
		Lt. Purple #45	.29	.32	.35	.37	.39	.42	66.4	71.3	76.3	80.6	83.9	87.2	91.5
		Dk. Green #50	.36	.39	.43	.46	.48	.51	82.3	87.2	93.4	99.4	104	108	112
		.35 10FC	Within the recommended pressure range of 25-50 PSI (1.75-3.25 BAR), the .35 10 FC flow control nozzle is flow regulating within a flow range of no more than 0% greater and 10% less than the nominal flow of .35 GPM (79.5 LPH).												
P4	P4 9" White Radius 18-22' (5.5-6.7 m) Stream Ht. 14-24" (36-61 cm)	Dk. Green #50	—	—	.43	.46	.48	.51	—	—	93.4	99.4	104	108	112
		Lt. Yellow #55	.44	.48	.52	.55	.59	.62	101	107	114	120	125	131	137
		Lt. Red #60	.51	.56	.61	.65	.69	.73	117	125	133	141	147	154	161
		.50 10FC	Within the recommended pressure range of pressure range of 25-50 PSI (1.75-3.25 BAR), the .50 10 FC flow control nozzle is flow regulating within a flow range of no more than 0% greater and 10% less than the nominal flow of .50 GPM (114 LPH).												
	P4 15" Orange Radius: 23-25' (7.0-7.6 m) Stream Ht. 40-50" (102-127 cm)														

Application Rate – Drip Emitters

- First step can be to measure the pressure – use chart →
- Measure discharge volume directly
- Microirrigation: application rate can be measured in in/hr

$$\text{Microirrigation Application Rate (in/hr)} = \frac{\text{Average Tree Application Rate (gph)}}{\text{Tree Spacing (ft}^2\text{)}} \times 1.6$$

- Measure pressure with:
 - Pressure gauge with drip fitting
 - Pitot tube on pressure gauge – punch hole in tubing, fix with goof plug

End of laterals



Punch hole & measure



Measure emitter volume



Non-pressure-compensating (NPC) drip emitters

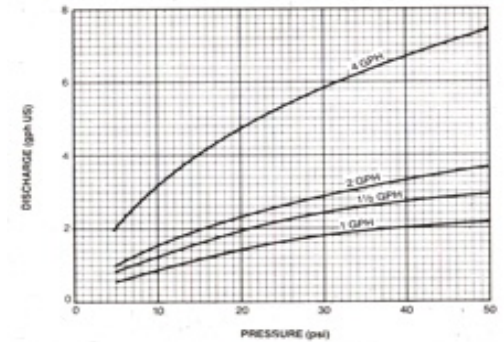

Pressure-compensating (PC) drip emitters

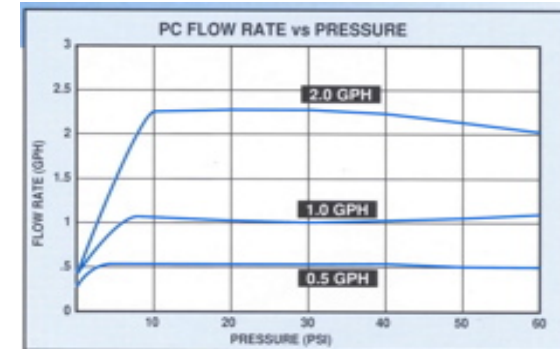

Application Rate - Microsprinklers

- First step can be to measure the pressure— Use chart →
- Measure volume directly – MS head in bucket
- Microirrigation: application rate can be measured in in/hr

$$\text{Microirrigation Application Rate (in/hr)} = \frac{\text{Average Tree Application Rate (gph)}}{\text{Tree Spacing (ft}^2\text{)}} \times 1.6$$

- This is easier than converting all ET (in) info. into gal/tree
- Measure pressure with:
 - Pressure gauge with drip fitting
 - Pitot tube on pressure gauge – punch hole in tubing, fix with goof plug

Non-pressure-compensating (NPC) microsprinklers

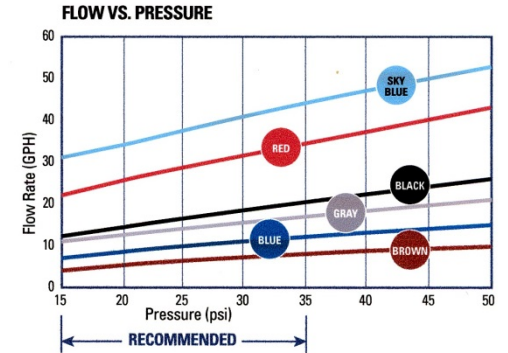

Pressure-compensating (PC) microsprinklers

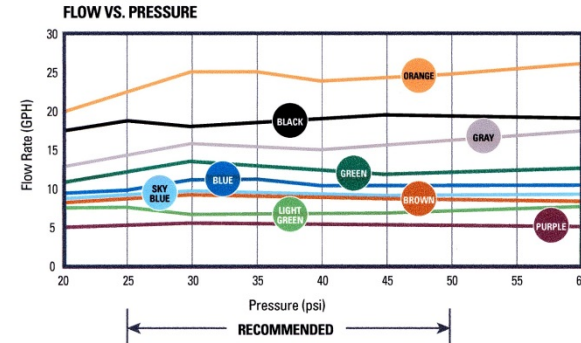

Irrigation Uniformity

- Why is it important?
 - Poor uniformity means that some areas of the orchard receive less water than others.
 - To adequately irrigate most areas of the orchard, non-uniformity means you end up over-irrigating much of the orchard.
 - Over-irrigating much of the orchard leads to irrigation inefficiency and leaching of water and chemicals (e.g. nitrates) present in the root zone.

Target Application = 1"

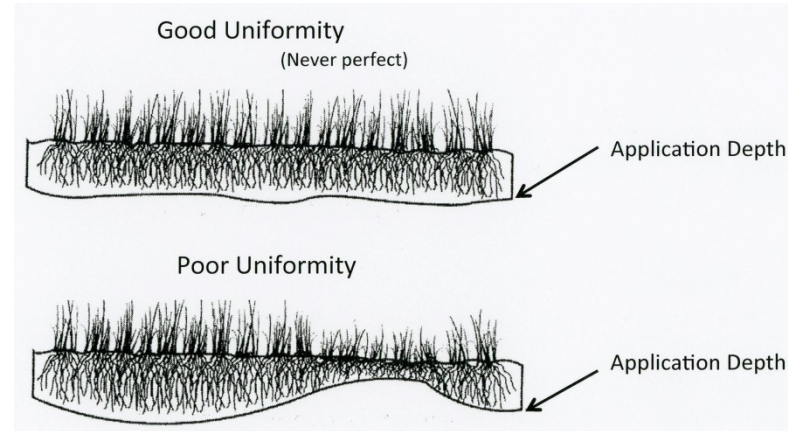
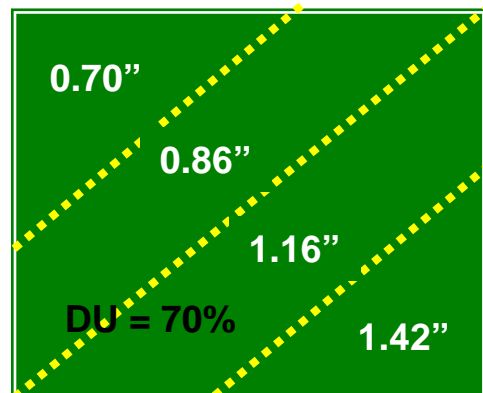
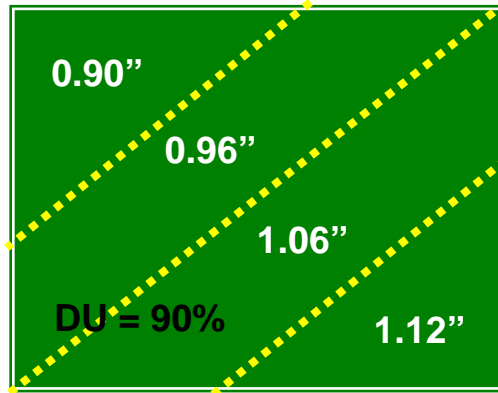

Irrigation Uniformities of Various Irrigation Systems

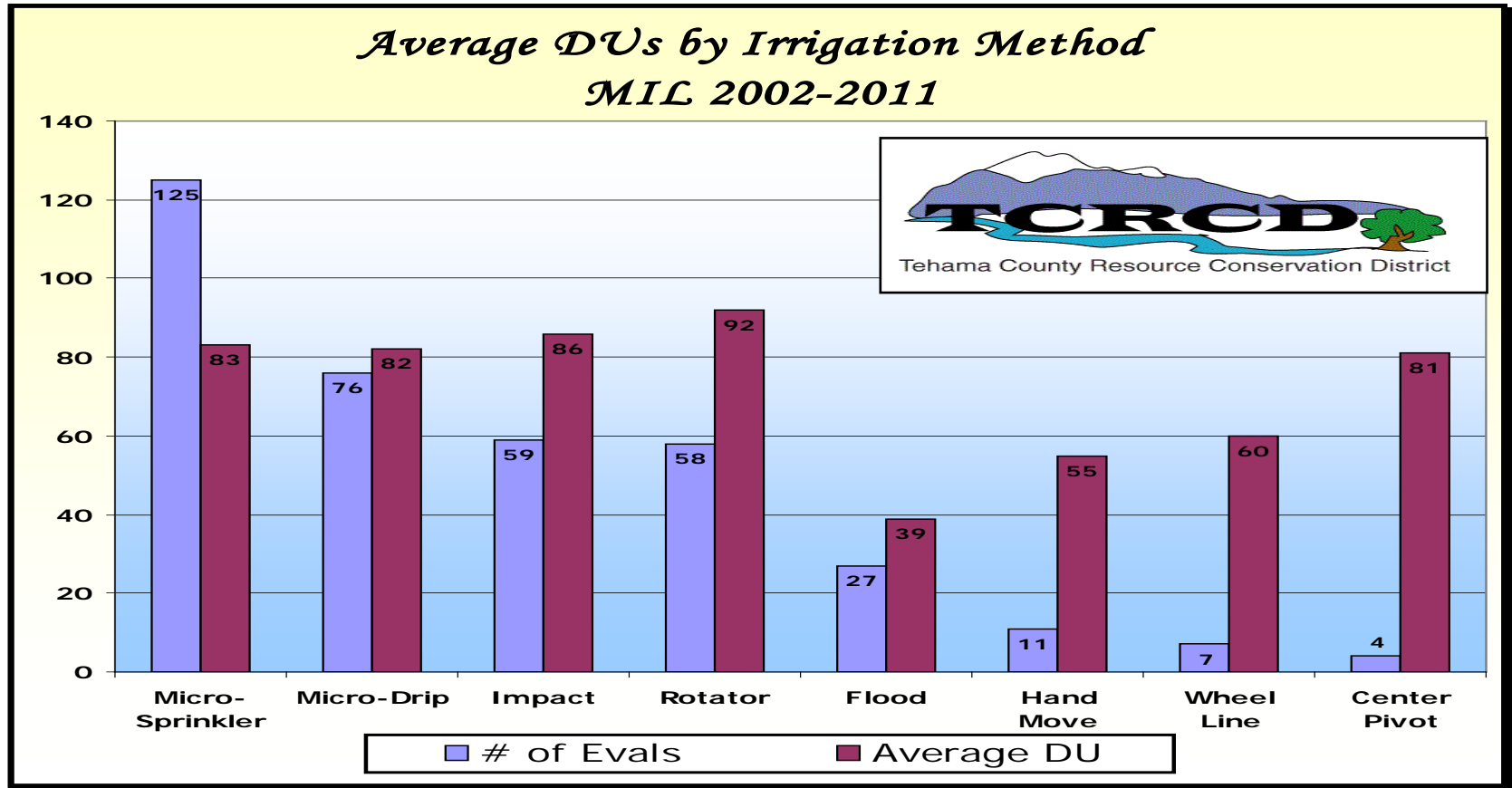

Distribution Uniformity

- Measuring the volume of water at strategic points throughout the orchard.
 - Close to the head of the system through the tail of the system.
- Determining: The amount of water necessary to ensure only 1/8 of the field is under irrigated.

Acceptable DU range from 85-95 %

If a planned irrigation of 3.5 inches was needed.

DU 70% $3.5 / .7 = 5.0$ in

DU 90% $3.5 / .9 = 3.9$ in

Improving Distribution Uniformity

- The Problem:
 - Pressure variation
 - Too high flow rate for design
 - Too small main, sub main, or lateral pipe size– friction loss
 - Elevation differences
 - Emitter/sprinkler variation



Monitor the Water Applied

- Know the applied water volume
 1. Keep good records of irrigation set times (hrs)

$$\text{Seasonal Water Application (in)} = \text{Application Rate (in/hr)} \times \text{Irrigation Time (hrs)}$$

2. Use a good **flow meter** – easier and more accurate

- Know the Application Rate (in/hr)

$$\text{Gallons} / 27154 \text{ gal per acin} / \text{acres irrigated} = \text{acre inches applied}$$



Water Meter Installation

- Turbulence in the area of measurement influences accuracy

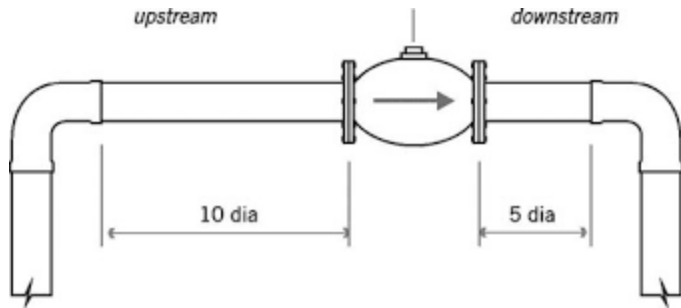

Almond Irrigation Improvement Continuum

Measurement	1.0 Minimum	2.0 Intermediate	3.0 Advanced
Irrigation System Performance	Evaluate irrigation system for pressure variation and average application rate at least once every 3 years. Correct any diagnosed system performance problems.	Assess distribution uniformity and average application rate by measuring water volume at least every 3 years. Correct any diagnosed system performance problems.	Assess distribution uniformity and average application rate by measuring water volume at least every 2 years. Correct any diagnosed system performance problems.
Applied Water	Use application rate and duration of irrigation to determine water applied.	Use water meters to determine flow rate and water applied.	Use water meters to determine applied water and compare to crop water use (ETc, evapotranspiration) to determine irrigation efficiency.
Orchard Water Requirements	Estimate orchard water requirements using “normal year” regional ETc to estimate irrigation demand on a monthly time step.	Estimate orchard water requirements using “normal year” regional ETc – adjusting for current weather and cover crop use on a bi-weekly time step.	Estimate orchard water requirements using “normal year” regional ETc to plan irrigations then use real time ETc data to correct the schedule on a weekly time step.
Soil Moisture	Evaluate soil moisture based upon feel and appearance by augering to at least 3-5 feet. Monitor on a monthly time step.	Use manually operated soil moisture sensors to at least 3-5 feet and monitor on a bi-weekly time step. Use information to ensure calculated water is not over/under irrigating trees.	Use automated moisture sensors that store data over time. Review weekly to ensure calculated water is not over/under irrigating trees.
Plant Water Status	Evaluate orchard water status using visual plant cues just prior to irrigation or on a bi-weekly time step.	Use pressure chamber to measure midday stem water potential just prior to irrigation on a monthly time step. Ensure calculated water applications are not over/under irrigating trees.	Use pressure chamber to measure midday stem water potential prior to irrigation on a weekly time step. Ensure calculated water applications are not over/under irrigating trees. Use it to assess when to start irrigating.
Management			
Integrating Approaches	Combine irrigation system performance data with “normal year” regional ETc estimates to schedule irrigations. Check soil moisture status with auger occasionally.	Use irrigation system performance data with regional estimates of “normal year” ETc to schedule irrigations and adjust based on feedback from monitoring soil moisture or crop water status.	Develop an irrigation schedule based on predicted “normal year” demand, monitor status using soil and plant based methods. Adjust irrigation schedule with real-time ETc as the season progresses.





**Allan Fulton,
UCCE – Tehama County**

Achieving Irrigation 2.0 + 3.0 Efficiencies

(Moving forward on ABC's Irrigation Improvement Continuum)

Allan Fulton

Irrigation and Water Resources Farm Advisor
Tehama, Glenn, Colusa, and Shasta Counties



ABC's Irrigation Improvement Continuum

- Level of engagement on continuum
 - Minimum
 - In transition
 - Advanced

- Types of measurement
 - Irrigation system performance
 - Applied water
 - Orchard water requirements (ET)
 - Soil moisture
 - Plant water status
 - Putting pieces of the irrigation improvement continuum together

Advanced Soil Moisture Monitoring Tools

Soil Moisture Tension Sensors



Volumetric Soil Moisture Sensors



Remote and Rapid Data Acquisition

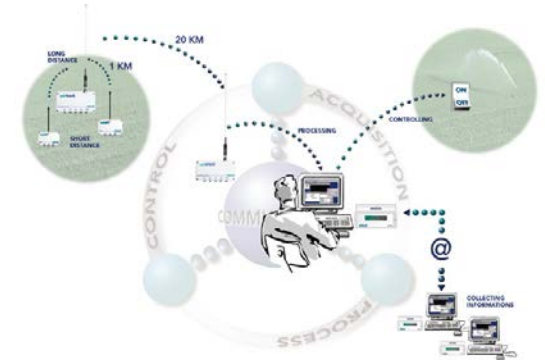

Soil Moisture Tension Sensors



Soil Moisture Tension

- A measure of surface tension or force that retains water to soil
- The tension increases as a soil dries, plants spend more energy to transpire water
- Unit of measure is usually centibars (cb)
- 0 cb – saturation, no tension
- 200 cb – low plant water availability, maximum detection level

Applying Soil Moisture Tension Measurements

Soil Tension (centibars)	Sand/Loamy Sand	Sandy Loam	Loam/Silt Loam	Clay Loam/Clay
	Depletion of the Plant Available Water (%)			
10	0	0	Not fully drained	Not fully drained
30	40	25	0	0
50	65	55	10	10
70	75	60	25	20
90	80	65	35	25
110	85	68	40	32
130	87	70	47	38
150	90	73	52	43
170	95	76	55	46
190	98	79	58	49

Table adapted from Scheduling Irrigations: When and How Much Water to Apply. Division of Agriculture and Natural Resources Publication 3396. University of California Irrigation Program. University of California, Davis. pp. 106.

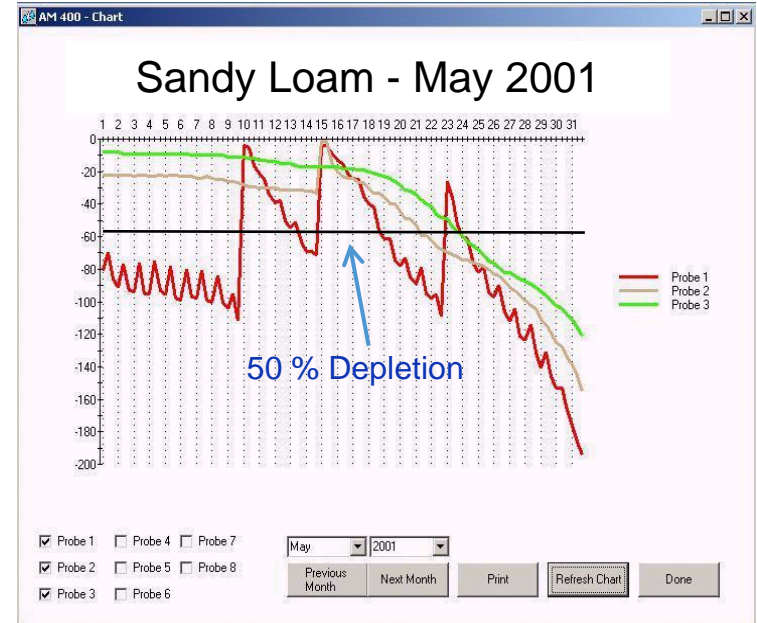

Advanced Volumetric Soil Moisture Monitoring Sensors



Dielectric Sensors

- Calibrated to measure moisture in percent by volume, inches, or mm
- Measure ability of material to establish an electrical field – “dielectric constant”
- More moisture increases ability of soil to concentrate electrical charge
- Air – Dielectric constant of 1.0
- Dry soil – constant 3.0 to 5.0
- Water – constant of 80.0
- Constant for moist soil will fluctuate between that of dry soil and water

Two Dielectric Methods

- **Frequency domain-reflectometry (FDR)** – capacitance probes – two electrodes separated by an insulator. When installed the soil bridges the electrodes and enables the concentration of the electrical field to be measured.
- **Time domain-reflectometry (TDR)** Waveguides are installed parallel to each other into soil. An electrical signal is applied to the waveguides and travels their length and is reflected back. The travel time is related to the dielectric constant of the soil and its moisture content.

Applying Manual Volumetric Soil Moisture Measurements

Soil Texture	Field capacity	Wilting Point	Available Water Capacity
	(Inches/ft of soil)		
Sandy loam	2.0	0.6	1.4
Fine sandy loam	2.6	0.8	1.8
Loam	3.2	1.2	2.0
Silt loam	3.5	1.4	2.1
Clay loam	3.8	1.8	2.0
Clay	4.0	2.6	1.4

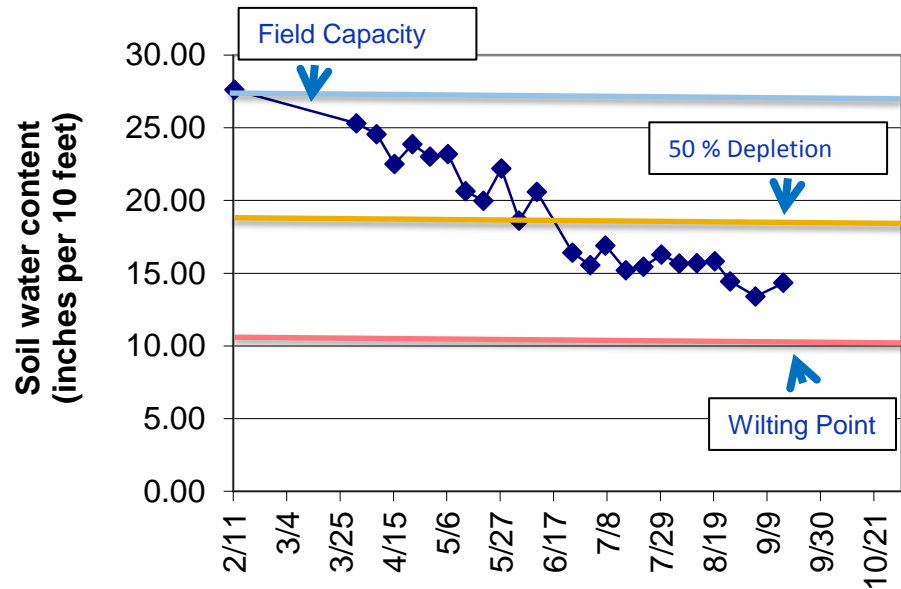

Applications of High Frequency Soil Moisture Sensors

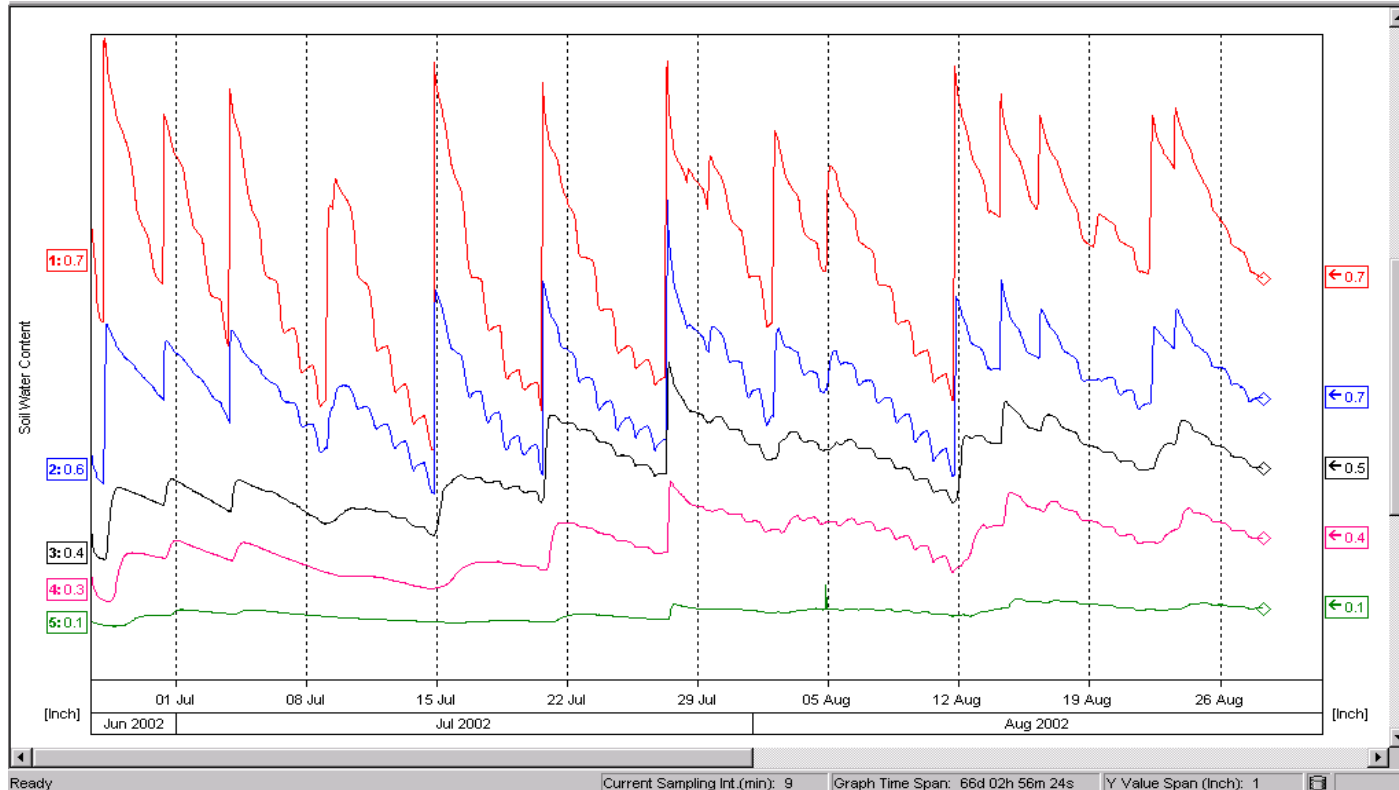

Concept of Detecting Crop ET and Water Stress with High Frequency Soil Moisture Monitoring

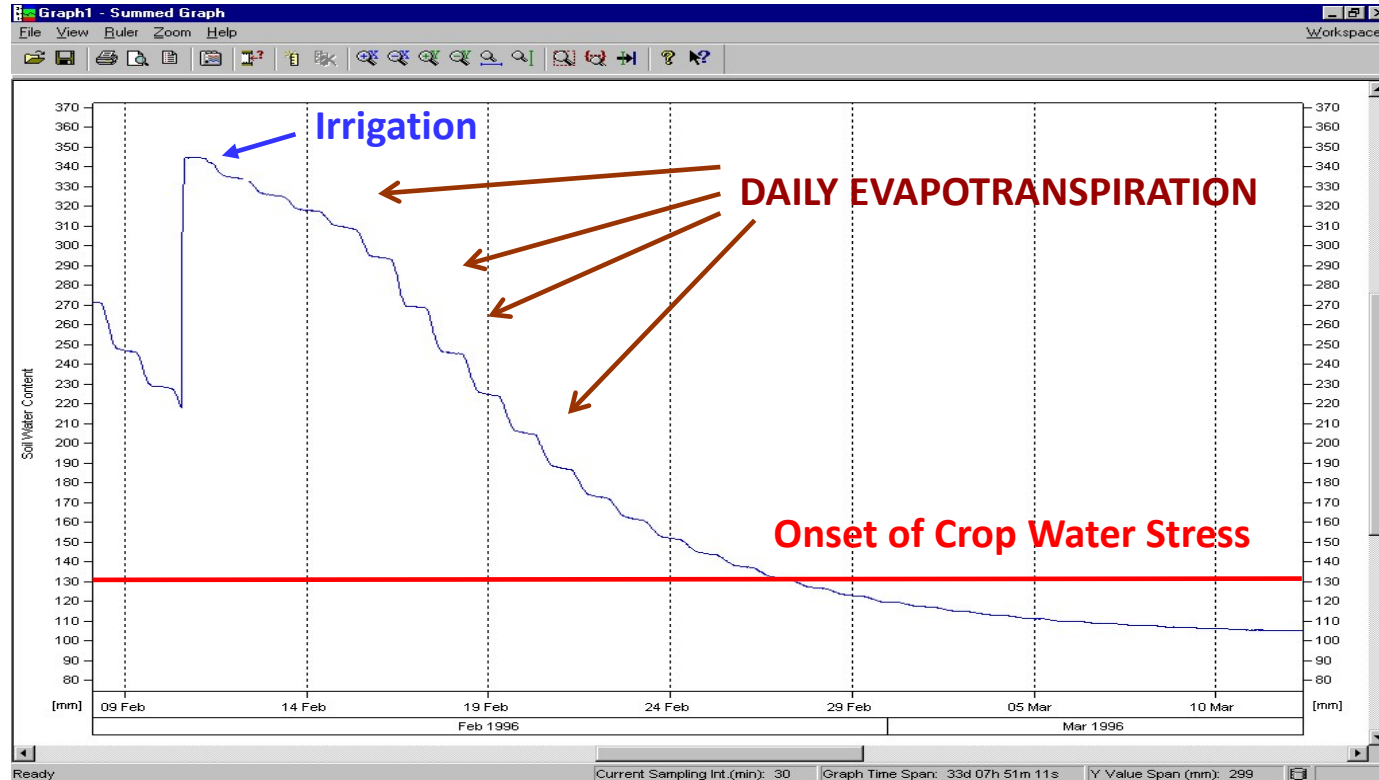

Concept of Evaluating Soil Moisture Availability with Depth

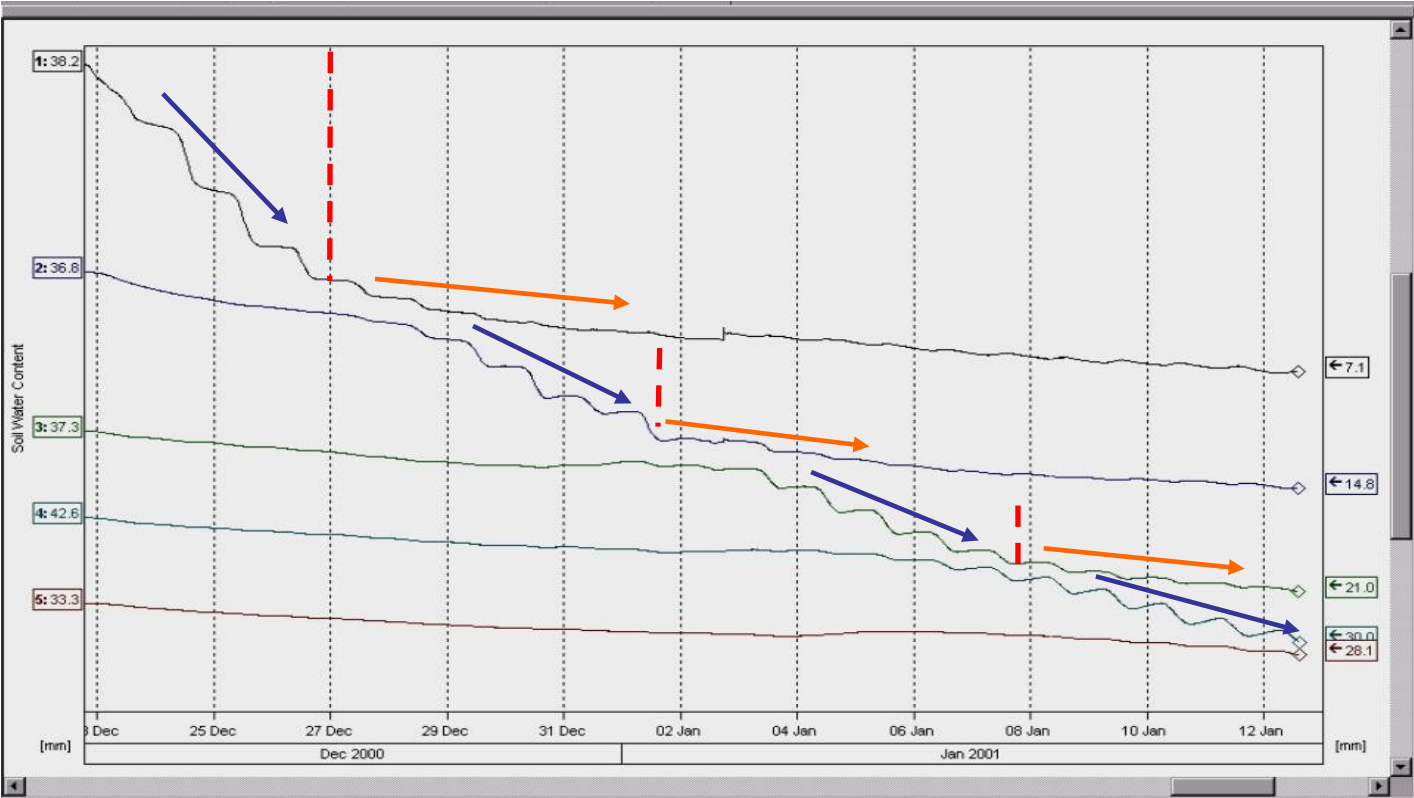

Applications of High Frequency Soil Moisture Sensors

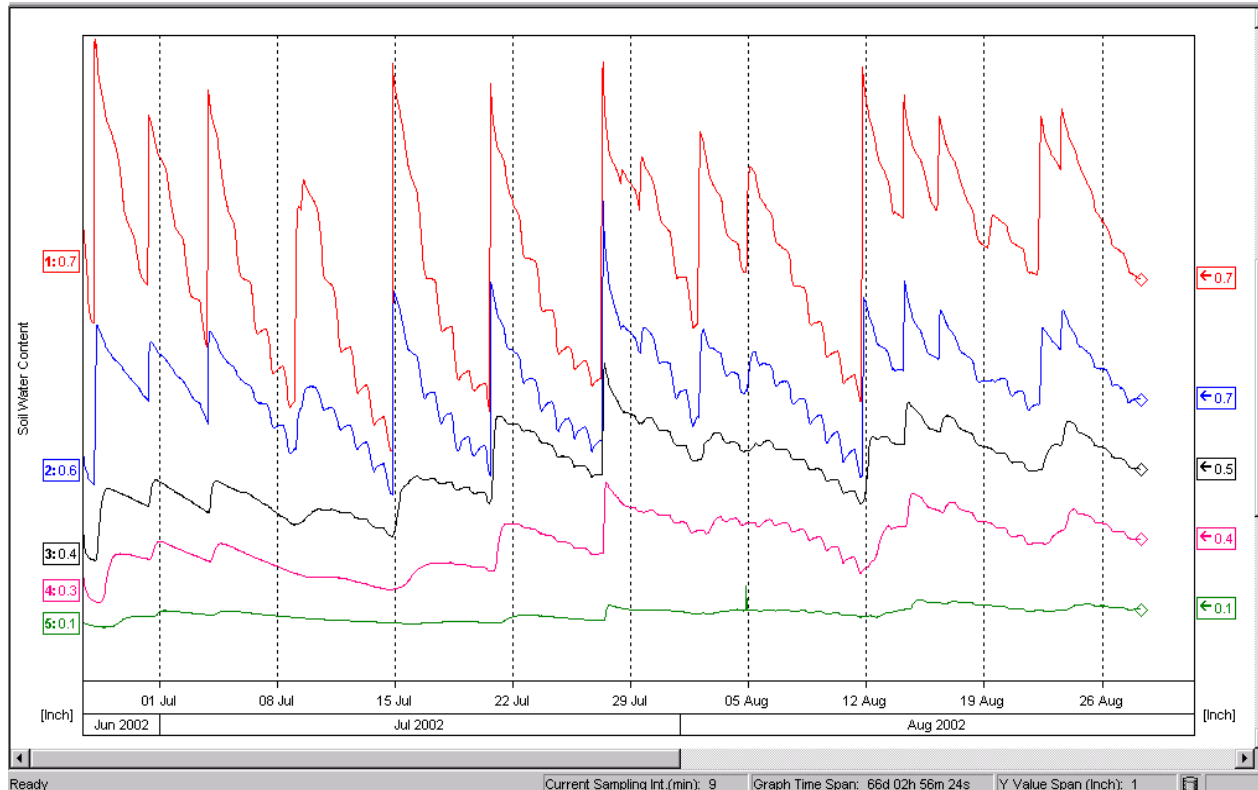

- Never see inflection (flattening of slope) from the lack of moisture availability at any of the sensor depths. Opportunity to stretch out irrigation frequency?
- Soil moisture levels at 3rd, 4th, and 5th depths trending upward during first half of July. Possibility to decrease irrigation duration?
- Soil moisture levels at 3rd and 4th depths do not decline until later July. Moisture levels at 5th depth do not change during the entire 60 day period. Possibility to decrease frequency and irrigation duration?

Soil Moisture Monitoring – Talking Points

1. Soil moisture monitoring can lead to improved irrigation decisions on frequency and duration.
2. Soil moisture sensors coupled with radio telemetry are “state of the art”.
 - Excel at convenient, timely delivery of information
 - Deliver more detailed information than manual measurements
 - Useful for measuring effective rainfall during dormant season
3. Sometimes acquiring representative data can be a challenge
 - Calibration questions
 - Soil and orchard variability
 - Root distribution, density, and depth of soil profile
 - Distribution of applied water
 - Small volumes of soil monitored
 - Gravelly soils and soils with shrinking and swelling characteristics

Advanced Monitoring of Plant Water Status

	Pressure Chamber
Basic Operation	Measures Water Potential
Requirement for Calibration	Varies by crop species
Monitoring Frequency	Manual Points in time
Zone of Measurement	Single to few trees
Replacement, Maintenance	Minimal
Major Challenges	Time involved. Midday heat.

Various Styles and Manufacturers of Pressure Chambers



Measuring Midday Stem Water Potential (SWP)



Applying Midday Stem Water Potential (SWP)

Water in plants is under tension, or negative pressure, so the scientific convention is to express SWP in negative values. An almond tree under -6 bars tension is under less stress than an almond tree under -15 bars tension.

The gauge on a pressure chamber does not usually indicate negative numbers, so a larger number on the pressure gauge indicates more tree stress.

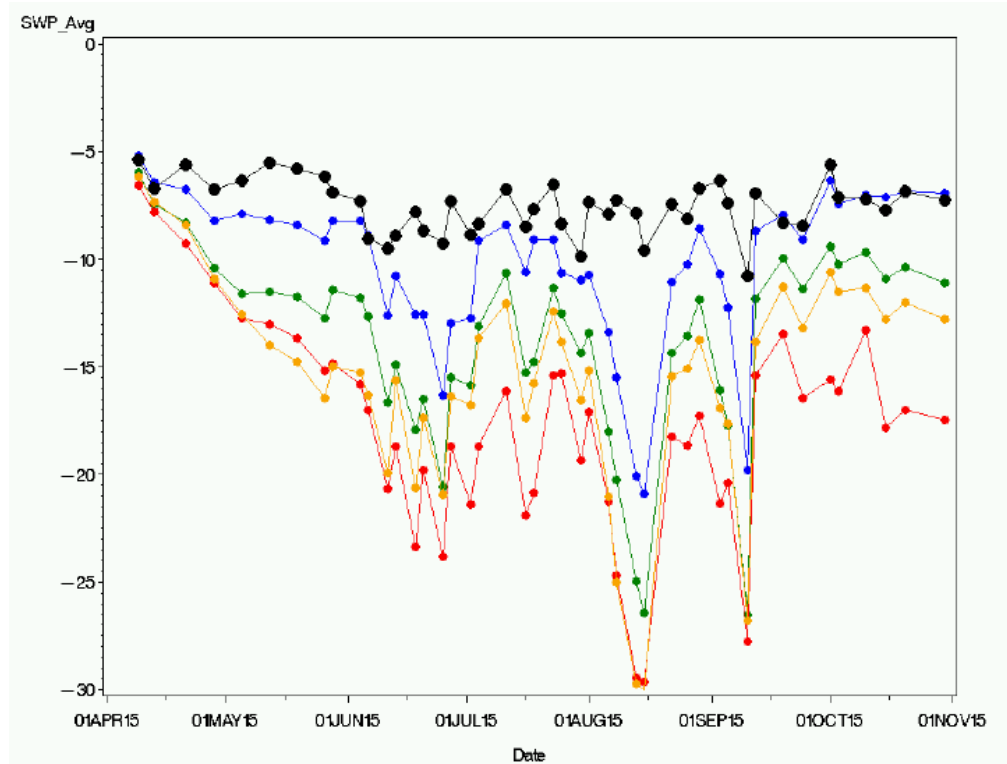

Google “UC ANR Publication 8503”

University of California
Division of Agriculture and
Natural Resources

ANR Publication 8503 | May 2014 UC
http://anrcatalog.ucanr.edu PEER
REVIEWED

Using the Pressure Chamber for Irrigation Management in Walnut, Almond, and Prune

INTRODUCTION

This publication describes how a pressure chamber is used to measure midday stem water potential (SWP) and how that information is used to guide irrigation scheduling decisions for walnut, almond, and prune. When used correctly, the pressure chamber can help growers and consultants save water, reduce irrigation costs, improve growth in developing orchards, and sustain higher levels of crop productivity while reducing tree loss and increasing orchard life span.

CONTENTS

Introduction.....	1	Pressure Chamber Operation and Measurement	10	How Is SWP Influenced by Other Orchard	23
How Water Moves in Trees: The Soil-Plant-Atmospheric Continuum.....	2	Technique.....	10	Variables?.....	23
Using the Pressure Chamber and Stem Water Potential in Orchards.....	5	Accessories and Suggestions for Measuring SWP Efficiently.....	12	Too Much or Too Little Water.....	23
Choosing a Pressure Chamber.....	5	Specific Guidelines for Interpreting SWP Measurements and Scheduling Irrigations in Walnut, Almond, and Prune.....	14	Soil and Water Salinity.....	23
Pressure Chamber Safety.....	5	Using SWP in Walnut Irrigation.....	14	Fruit or Nut Set (Crop Load).....	23
SWP Measurement Units.....	6	Research Basis for Walnut Guidelines.....	15	Soil Fertility and Plant Nutrition.....	23
Time of Day and Frequency of SWP Measurements.....	7	Using SWP in Almond Irrigation.....	17	Tree Diseases.....	24
Selecting Trees to Measure SWP: Mature Orchards.....	8	Research Basis for Almond Guidelines.....	18	Other Pests.....	24
Selecting Trees to Measure SWP: Young Orchards.....	8	Applying SWP in Prunes.....	20	Rootstocks and Cultivars.....	24
Selecting and Bagging Sample Leaves.....	9	Research Basis for Prune Guidelines.....	20	Orchard Canopy Management.....	24
		Using Baseline Predictions to Interpret Orchard SWP Values.....	21	SWP: Stand-Alone or Complementary Irrigation Management Tool?.....	24
				References.....	25
				For More Information.....	27
				Measurement Conversion Table.....	27

ALLAN FULTON, UC Cooperative Extension Farm Advisor, Tehama County; JOE GRANT, UC Cooperative Extension Farm Advisor, San Joaquin County; RICHARD BUCHNER, UC Cooperative Extension Farm Advisor, Tehama County; and JOE CONNELL, UC Cooperative Extension Farm Advisor, Butte County

Table 7. Guidelines for interpreting SWP measurements in almond.

Pressure chamber reading or SWP measurement (- bars)	Extent of crop stress and types of crop responses associated with different SWP levels in almond
0 to -6.0	Not commonly observed in almond.
-6.0 to -10.0	Low stress (when fully irrigated). Stimulates shoot growth, especially in developing orchards. Higher yield potential may be possible if these levels of crop stress are sustained over a season, barring no other limitations related to frost, pollination, diseases, or nutrition. Sustaining these levels may result in higher incidence of disease and reduced life span.
-10.0 to -14.0	Mild stress. Suitable from mid-June until the onset of hull split (July). Still able to produce competitively. Recommended crop stress level after harvest. May reduce energy costs or help cope with drought conditions.
-14.0 to -18.0	Moderate stress. Stops shoot growth in young orchards. Mature almonds can tolerate this level of crop stress during hull split (July/August) and still yield competitively. May help control diseases such as hull rot and alternaria, if present. May expedite hull split and lead to more uniform nut maturity. Also may help reduce energy costs and cope with drought conditions.
-18.0 to -20.0	Moderate to high stress. Should be avoided for extended periods. Likely to reduce yield potential, and may contribute to lower limb dieback.
-20.0 to -30.0	High stress. Wilting observed. Some defoliation. Impacts yield potential.
-30.0 to -60.0	Very high to severe stress. Extensive or complete defoliation is common. Trees may survive despite severe defoliation and may be rejuvenated.
less than -60.0	Trees are likely to die.

Monitoring Plant Water Status – Talking Points

1. Applying midday SWP is better understood than other methods at this point. It uniquely integrates and quantifies how an orchard is responding to soil, water, and climatic conditions.
2. SWP can help confirm and adjust assumptions that are used with soil moisture monitoring or when using ET and a water budget.
3. Must go into the orchard routinely on potentially hot afternoons.
 - Labor intensive – a negative for some
 - Encourages routine observation of an orchard, a positive for others
 - Limited acreage that can be monitored in a day and with one instrument
4. Concern: “by the time SWP responds, deep soil moisture is gone and you can’t get it back”.
 - Use SWP in combination with ET and water budget or soil moisture monitoring (*preferred*)
 - Resolve this through trial and error (*not preferred*)
5. Coping with orchard variability and achieving representative monitoring can be a challenge, usually less than for soil moisture monitoring.
6. Comment: “Currently use midday SWP to make irrigation decisions but foresee even greater management potential if there was a way to acquire high frequency crop water stress indicators”.

Some Alternative Sensors for Monitoring of Plant Water Status



Dendrometers



Leaf Monitors



Aerial Imaging

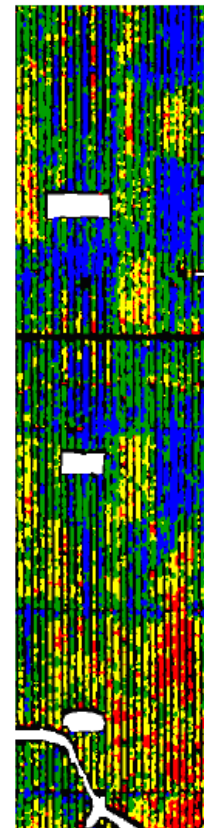

Objective of Alternative Methods of Plant Water Status Monitoring

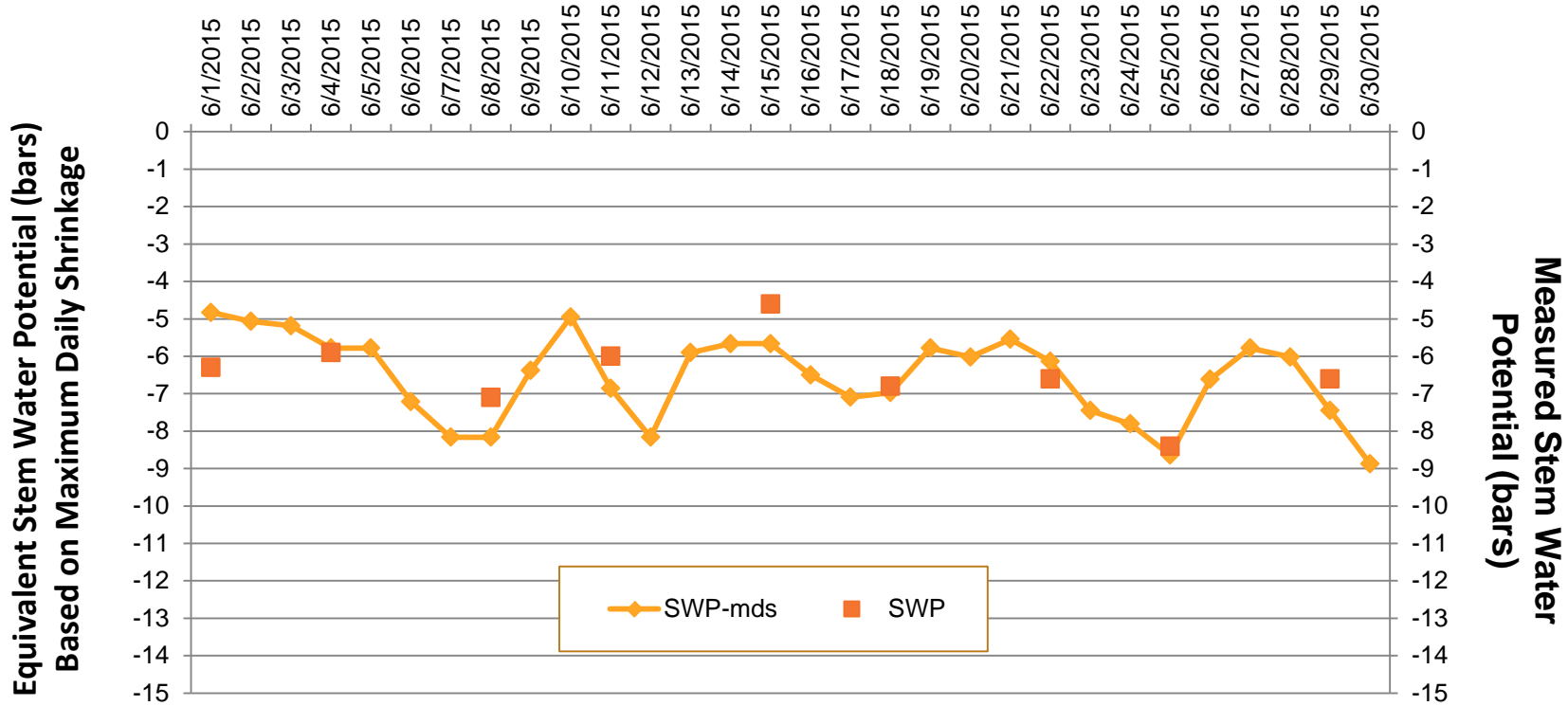

Putting Pieces of ABC's Irrigation Improvement Continuum Together



People and Time Intensive
Irrigation Tools



More easily automated
irrigation Tools to Reduce
Time and Labor and Improve
Execution of Irrigation
Management



Telemetry Equipment to
Reduce the Cost and
Increase the Ease of Data
Acquisition, Analysis, and
Decision Making

Putting Pieces of ABC's Irrigation Improvement Continuum Together

- Examine Motivations

- Higher production potential and nut quality, more consistent production, and extended orchard longevity
- Environmental stewardship and being positioned as well as possible to engage public concerns
- Farming is inherently risky so taking informed risks should help sustain the farm operation

- Reality Check

- Can't try or do it all
- Exercise preferences that reflect individual farming operations
- The almond growing environment is amazing and transcends our technology and know how

- Just Do It 

- Attention first to measuring applied water and irrigation system performance
- Suggest an approach that includes ET and a water budget and adapts based upon feedback
- Frequency of monitoring is a key to progressing along the irrigation improvement continuum

- Determination, Resilience, and Reward

Thank
You!

